

Article number: 0110069

Description: Retaining ring JS 52x2,5  
Springsteel

## Measures

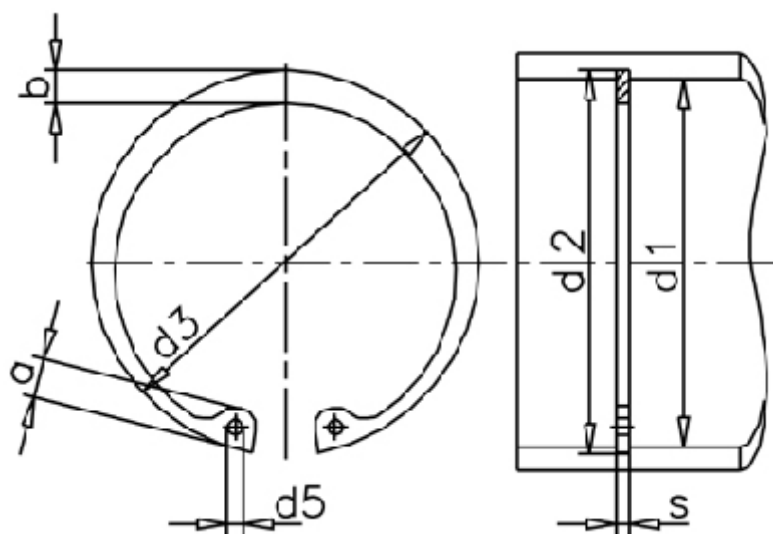

a max = 7.7	Description = JS 52	t = 1.50
AN mm <sup>2</sup> = 252	FN kN = 42.0	tol = 0.30
B = 1.57	FRg kN = 18.8	tol = +1,10 -0,46
b = 4.7	FR kN = 94.6	tol = -0.07
d1 = 52	g = 2.0	Tong = ZGJ-3
d2 = 55.0	m min = 2.65	Weight kg/1000 = 9.9
d3 = 56.2	Nominal drive = 4.5	
d5 min = 2.5	s = 2.50	